

The module allows monitoring of events occurring in alarm and security systems as well as operation in remote control systems by means of SMS notifications and CLIP calls, in any GSM mobile phone network 900/1800 MHz. In remote control operation, devices can be directly connected to its relay outputs and controlled also by means of SMS & CLIP (Calling Line Identification Presentation - a supplementary GSM service used to show the number of a caller). Specified below are characteristic features of Elmes GSM2000 module:

- Mobile phone integrated GSM transceiver chipset (CE, FCC and SGS certified).
- 4 control inputs, each with programmable switching levels in the range of 0.2 - 14,5V and programmed hysteresis in the range 0,1 - 5V.
- Four SMS controlled and isolated relay outputs with NO (Normally Opened), or NC (Normally Closed) terminals – see Fig.1 below.
- Relay outputs operation in pulse mode (programmable time-lapse), or on/off mode (bistable).
- Outputs are set on by means of SMS or CLIP from up to 2048 phone numbers.
- Alarm monitor SMS & CLIP notifications sent to up to six preregistered phone numbers.
- The ability to remotely add and delete phone numbers supported by the module.
- Periodical communication test by SMS or CLIP sent to one or two phone numbers, at user's specified time of day or time interval.
- SMS information of all inputs and outputs status.
- The ability to remotely execute AT commands.
- User set limited number of SMS notifications sent daily.
- TAMPER switch monitoring of module's box cover opening.
- Module configuration, firmware upgrade and user preference parameters are set in "GSM2 Configurator" software made for Windows® based PC (Personal Computer). The software is available for download at manufacturer's web site: www.elmes.pl

Control Inputs

Elmes GSM2000 module features four control inputs with 15VDC(!) maximum allowable input voltage level, as measured with reference to module's ground (minus power supply). "GSM2 Configurator" software specifies the following parameters for each input module:

- The level of input switching voltage in the range of 0.2 - 14,5V, and the voltage hysteresis in the range of 0.1 - 5V, set for each input individually.
- Input set on (activation) voltage level – high (H) or low (L).
- Phone numbers to which SMS notifications are sent on input set on (change from inactive to active).
- Phone numbers to which SMS notifications are sent on input set off (change from active to inactive).
- SMS notification text contents on input set on and off (up to 63 characters each).
- Phone numbers CLIP calls are made to on input set on.

When CLIP call is made to phone number engaged or unavailable, the call is redialed twice. First however, the module attempts to call remaining phones in predefined list and then returns to redial the unmade call. Calls are considered made when:

- call is rejected;
- call is received and ended by call recipient;
- call is received and ended by the module due to predefined notification time passage (up to 99 seconds);

If a call is neither rejected nor received, but the defined notification time has passed, the module would not acknowledge the call as received and will attempt to redial two times. This function can be deactivated - then the module calls only once.

Control Outputs

The GSM2000 module features four control relay outputs. Each output has two installation terminals jumper configured to operate in normally opened (NO), or normally closed (NC) mode (see figure 1). Outputs feature the following "GSM2 Configurator" software set parameters:

- output name (up to 16 characters max.);
- one of four possible operating modes;
- selection whether output's relay sets ON or OFF on output activation.

Outputs can be controlled by SMS command sent to the module. The user sets the following parameters:

- whether SMS command is protected by preceding password;
- whether SMS command can be sent from any, or module listed only phone numbers;
- whether SMS command letters case (lower or upper) has meaning;
- whether the module confirms command execution by return SMS or, in case of an error, confirms command rejection.

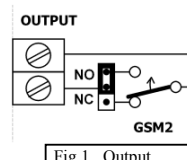

Fig.1 Output

The GSM2000 outputs can be also remotely controlled by calling (ringing) to module's number from any phone registered on its list of up to 2048 phones. Each of these phone numbers may have predefined one or many control outputs assigned for simultaneous operation. This mode allows programmed time pulse control of outputs only (bistable "on/off" operation is not available). The third and last available control mode of GSM2000 allows predefined output/s control by violation of inputs. In this mode an output can work in monostable mode (modes 1 and 2) or bistable (modes 3 and 4), as described in the table below.

Table 1: SMS text command pattern depends on selected operating mode of module's outputs, as below:

Output's Operating Mode	Examples of SMS commands content and their meaning
1. Pulse Mode with preset set on time.	„OUT1” – Sets on output OUT1 for time preset in GSM2 Configurator
2. Pulse Mode with set on time defined in SMS text.	„OUT1 1:30” – Sets on output OUT1 for 1m30s „OUT1” – Sets on output OUT1 for time preset in GSM2 Configurator
3. Bistable Mode – on/off.	„OUT1 Y” or „OUT1” – Sets stable on output OUT1 „OUT1 N” – sets off output OUT1
4. Any mode defined in SMS command	„OUT1” – Sets ON output OUT1 for time preset in GSM2 Configurator „OUT1 1:30:00” – Sets on output OUT1 for 1h30m „OUT1 Y” – Sets on output OUT1 stable until set off command is received „OUT1 N” – Sets off output OUT1

Remarks: SMS text commands should be separated by a space and quotation marks should not be used!

- After applying name to output, the name should be then used in SMS commands, e.g. „STOVE 1:30:00” (switch on stove for 1h30m).
- In output bistable operation mode, letters T, Y, t, y can be used to mark set on while N, n to mark set off.
- In monostable (pulse) operation mode, output set on time can be specified as: HH:MM:SS, MM:SS or SS where “:” can be substituted by . / \ e.g. „OUT1 1.40.00” (one hour and 40 minutes); „OUT1 5/20” (5 minutes 20 seconds); „OUT1 6” (6 seconds).
- Single SMS command can control any number of outputs, e.g. „OUT1 OUT2 5 OUT3 T OUT4 12.00”.

Correct SMS command is executed immediately after received and, if this option is selected, confirmed in return by SMS with “OK” or information on all inputs and outputs status. If SMS command contained any error, such as improper output name, incorrect password or content, the command is not executed and, if this option is selected, “ERROR” SMS is returned. Typical error could be SMS command

“OUT1 Y” sent to output that operates in monostable mode (1 & 2) or, execution of SMS command “OUT1 5:00” when the output is defined to operate in mode 1 (Pulse Mode with predefined set on time), etc.

Communication Test

GSM2000 module features periodical communication test by making CLIP call or sending SMS to one or two predefined phone numbers. The SMS text containing up to 31 characters is defined by user. In addition, the contents of the SMS can include the state of the inputs and outputs. In “GSM2 Configurator” it is possible to define whether the test is performed once daily at specified time, or at specified time interval, e.g. every 8 hours. In the first case, module’s real time clock should be set first either in Configurator software, or by SMS with password followed by text “TIME HH:MM:SS” or “TIME HH:MM”. Example: “TIME 12:30” sets the real time clock to 12:30. Then set start time of communication test. **IMPORTANT!** SMS must start with valid password.

Periodical test can be forced to perform at any time by resetting test time counter, e.g. by sending SMS with “RESTART”. Within a minute the test will be performed and next test will be made after preset time interval, e.g. after 8 hours. **IMPORTANT!** SMS must start with valid password.

Communication test can also be done at any time by calling to the module from any of its listed phones. The call would be rejected and, if the option is set on, a return call will be made confirming proper communication status.

Module Status

The module status is an SMS describing the state of its inputs and outputs. It is send in response to an SMS with the text "STATUS" or SMS which controls outputs. It can also be sent periodically during the test module. The status may be presented in a simplified form, eg.: "IN1..4 = 1000, OUT1..4 = 0100", or expanded. In this case, when the zone is triggered, the contents of the SMS will be according to full description of inputs and outputs defined in the software “GSM2 Configurator”.

Remote edition of phone number list

It is possible to add and delete phones from the list by SMS, but only by one phone number with appropriate authorization. Example SMS which adds/deletes number to/from the list should be of the following pattern respectively: "ADD +44123..." or "DEL +44123...". The phone number must be in the international syntax, e.g. in England must begin with: +44 **NOTE:** SMS can only add/delete phone to/from the list, but not select which output can be controled, or whether the module can accept incoming SMS from this number. Therefore, these options must be earlier set up by "GSM2 Configurator".

Remote AT commands (recommended for experienced users only)

Any AT commands can be executed at the start of the module. These special commands are send directly to the GSM radio chipset used in the device and allow additional functionality. An example is to force the module to log on to GSM network other than the default GSM provider. For more information see extended user’s manual of GSM2000 chipset ready for download from manufacturer’s internet site.

Programming the Module

IMPORTANT! Before the first use of GSM2000 module prepare an active SIM card. The card must be SMS and contact book memory cleared as well as voice mail function set OFF. A card with PIN pass code function set on or off may be used. If PIN code is set on it should be set to **1234**. If the code is different, it can be set to required 1234 code in any mobile phone operating in the same GSM network. The use of SIM card with **PIN code other than 1234 is not allowed** and may result by the card being blocked.

NOTE: Before programming the module should be powered on and connected to a PC computer.

GSM2000 module can be programmed and tested with „GSM2 Configurator” PC software before, or after installation. The latter allows GSM diagnostics, e.g. GSM signal reception test in place of module installation. To connect the module to PC a dedicated Elmes made mini USB-RS cable (sold separately) is needed. The cable can be optionally ordered from Elmes Electronic or its distributors. To use the cable a dedicated software driver must be installed on the PC. GSM2 Configurator software as well as mini USB-RS cable driver can be downloaded from the manufacturer web site: www.elmes.pl. The user should make sure that GSM2 Configurator software current version is installed on the PC. If not, then it should be uninstalled by means of Windows® Control Panel Add/Remove tool and then the latest version installed.

(!) Below listed steps order should strictly be obeyed when connecting GSM2000 to a PC:

1. Make sure SIM card with PIN 1234 is inserted in module’s SIM socket.
2. Connect power supply to the module (12VDC/1A).
3. Connect mini USB cable plug to socket in the module.
4. Connect USB cable plug to USB socket in PC.

When disconnecting, reverse steps should be followed.

JP Jumper Use

The jumper is used only if module’s firmware upgrade process has not succeeded properly, e.g. power supply set off while in upgrading. In that case, the jumper should be set ON followed by power supply switched on. The module starts firmwre upgrade now.

Installation

The module can be installed indoor only, in dry place. Poor GSM signal reception places should be avoided. To improve reception a dedicated external GSM antenna can be used and connected to SMA socket, in place of the supplied antenna. With the supplied screws bottom part of the module’s plastic case should be installed to wall observing upwards direction of module’s antenna. SIM card should be inserted, antenna screwed in and input-output wire connections should be made with cables put through dedicated cable hole in the bottom cover, or through holes made in purpose. Connection of power supply is signaled by fast flashing LED. Slow flashing LED, ca. every three seconds, indicates module registration in GSM network. Registration procedure takes 30 to 60 seconds.

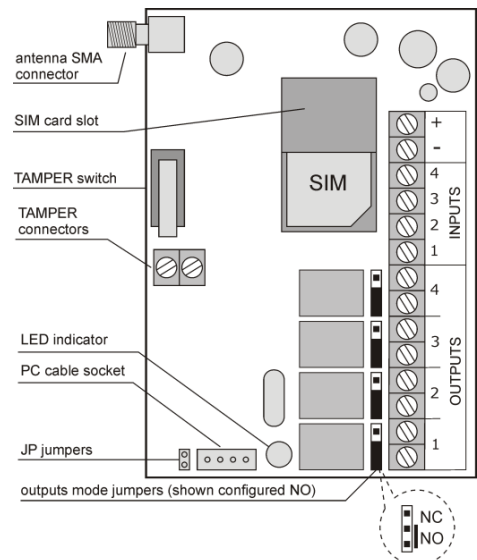

Input Control Wiring Examples

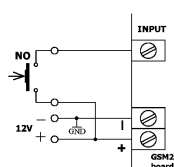

A. Input controlled by +12V, NO activation level H

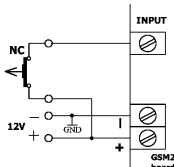

B. Input controlled by +12V, NC activation level L

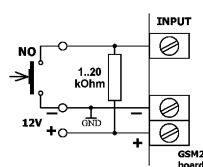

C. Input ground controlled, NO activation level L

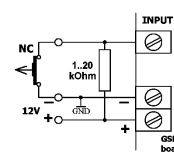

D. Input ground controlled, NC activation level H

NOTES!

1. Grounds of external control device and GSM2000 module must be shorted.
2. NC – normally connected state at standby. NO – normally opened state at standby. Change of state activates input. See charts above.
3. Resistor in examples C and D in 1kOhm..20kOhm range. Optimal value 4.7 kOhm. Note that input resistance to ground is 38 kOhm.
4. GSM2000 inputs activation level (H – high, or L – low) is selected with „GSM2 Configurator” software.

Specification

Integrated GSM transceiver chipset (CE declaration and certificate included).
 Power Supply: **10- 20VDC, current rating 1A minimum!**, standby current 6mA.
 Four control inputs rating 0..15VDC maximum with reference to ground (-V power supply).
 Four control relay outputs NO/NC type rated 0,5A/130VAC or 1A/30VDC.
 Mobile phone remote control from up to 2048 phones numbers. Notification to up to 6 phone numbers.
 Operation ambient temperature range: -20 to + 70°C. Dimensions: (L/W/D) 96/63/28mm, without antenna.



Manufacturer: ELMES ELECTRONIC, 54-611 Wroclaw - PL, Avicenny 2, tel. +4871784-59-61, fax +4871784-59-63

PROGRAMMING THE GSM2000 MODULE

Programming and diagnostics of GSM2000 is made in „GSM2 Configurator” PC software application, connecting the module to PC by commonly available mini-USB cable type B (see side fig). The cable is not supplied with the module and can be optionally ordered from Elmes Electronic or its distributors. To use the cable a dedicated software driver must be installed on the PC. GSM2 Configurator software as well as mini-USB cable driver can be downloaded from the manufacturer web site: www.elmes.pl.

Described below is procedure of mini-USB cable driver installation:

Connect power supply to the module and by means of mini-USB cable connect it to the PC. The PC should detect new device and display “USB serial Converter” notice followed by “Can Windows connect to Windows Update to search for software?”. Select yes and allow for search or, select “Install software from list or specific location” and define driver location earlier downloaded from www.elmes.pl site. Dedicated driver for currently produced modules is “..\USB cable drivers\VER 2A”.



After driver installation the system detects next device “USB Serial Port” and a new COM port appear (e.g. COM3, COM4 or higher). Number of the new COM port assigned to GSM2000 module can be checked in two ways:

1. Check list of available COM ports in “GSM2 Configurator” software in menu Options before connecting mini-USB cable to the module and after the connection. Appearing new COM port then is the right port number.
2. Click “My Computer” with right mouse switch and select “Hardware” in folder “Properties”. Now, select “Device Manager” and all hardware devices installed in the computer will be displayed. The new COM port number assigned to GSM2000 will appear in subfolder “Ports (COM and LPT)”. Check that subfolder for any new COM appearing after cable connection. That will be the port we are looking for.

First step after launching “GSM2 Configurator” is selection of serial COM port for communication with the module – menu Options->Settings, field **A.1**. The same port should be selected as used for USB cable installation. Module GSM2000 must be powered and mini-USB cable must be connected to the computer otherwise it will not appear in the selection list.

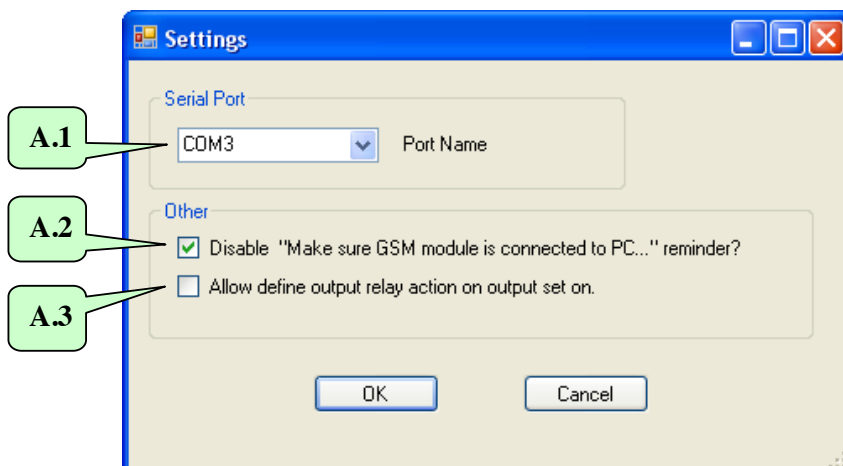

Other options in this menu:

Check box **A.2** allows disabling reminder message appearing every time setting data is send to or received from the module. Meaning of option in box **A.3** is described in menu "Outputs" – pt. 2.

When connecting GSM2000 to a PC computer, the following steps should be strictly obeyed:

1. Make sure SIM card with PIN 1234 or without PIN code protection (requires firmware 2.11 or higher) is inserted in SIM socket of the GSM2000.
2. Connect power supply to the module (12VDC/1A).
3. Connect mini-USB cable to GSM2000 module and PC.

Next step is to set all parameters and options of programmed module (pt. 1 to 7). After all options are set, it is suggested to save them to HDD by clicking **B.2** in main window menu. The data may be useful for future use or, when installing next module. Programming is effective when all set options are sent to the module by clicking **B.4** in main window menu. The programmed settings will remain the module memory even after power supply is off.

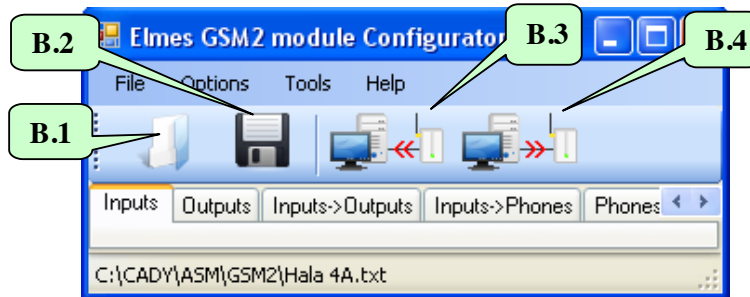

1. „Inputs”

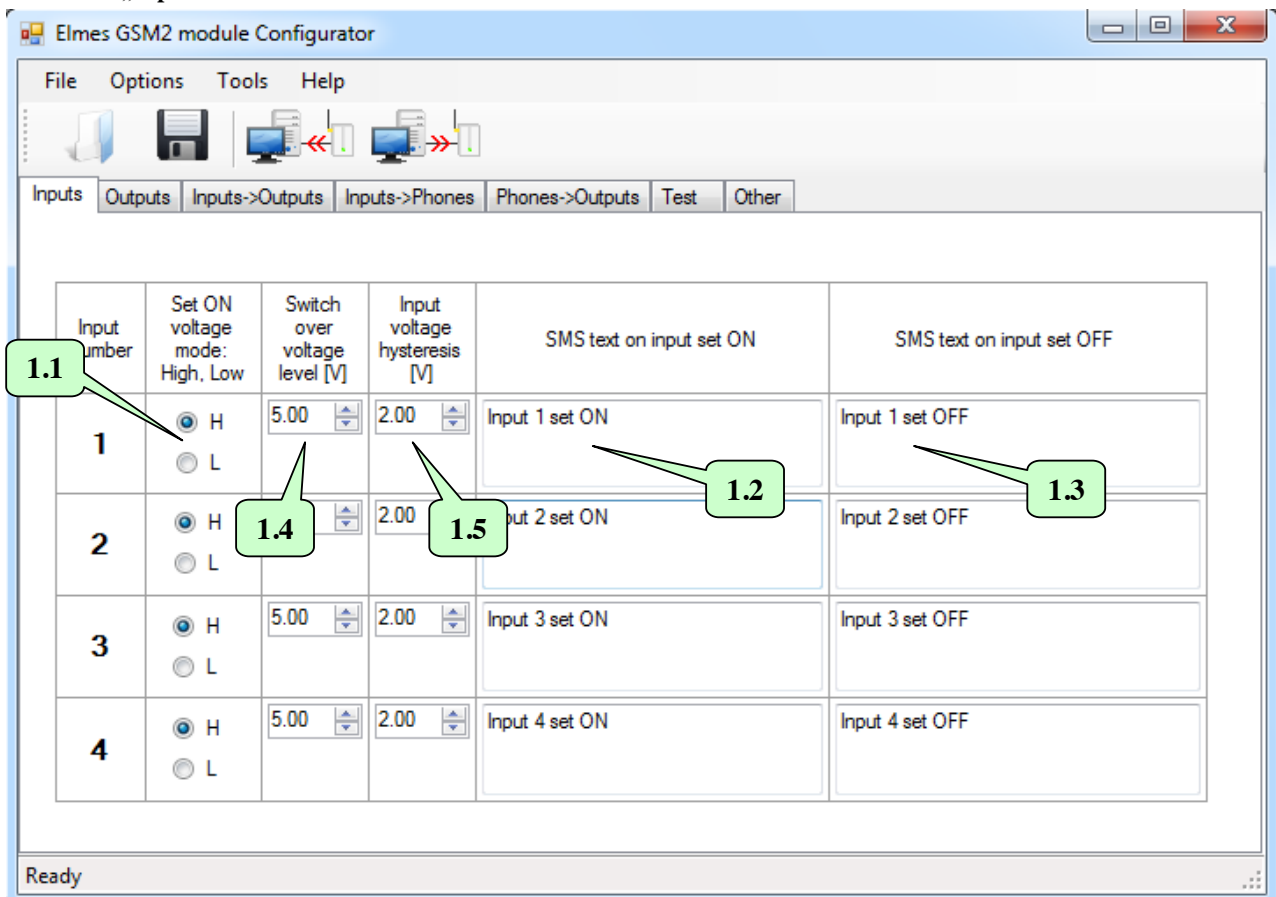

Elmes GSM2000 module features four control inputs with 15VDC(!) maximum allowable input voltage level measured with reference to module's ground (minus power supply).

Input voltage level below **1.4** - **1.5** is regarded as low -L (5V-2V=3V as default) while voltage level above **1.4** + **1.5** is regarded as high - H (5V+2V=7V as default).

Parameters defined for every input:

1.1 - Selection button of input trigger voltage level – low (L), or high (H). Selection of H or L trigger level means that when the input voltage level rises from low to high (H) or drops from high to low (L), SMS notification predefined in field **1.2** is send and calls are made to predefined phone numbers. When input signal voltage drops from H to L (H selected) or rises from L to H (L selected), only SMS notification, defined in field **1.3**, is send (no calls are made). Phones to be notified and type of notification (SMS and/or CLIP) are defined in menu “Inputs->Phones”.

1.2 - In this field input activation (set on) SMS text is defined.

1.3 - In this field input deactivation (set off) SMS text is defined.

1.4 - In this field switch over voltage level is defined in the range of 0,2-14,5V. If input voltage exceeds switch over voltage by more than hysteresis defined in field **1.5**, the input will be regarded as high (H). If it falls below switch over voltage by more than hysteresis then it will be regarded as low (L).

1.5 - In this field switch over hysteresis is defined in the range of 0,1-5V.

Inputs control signal level (L) or (H) wiring examples.

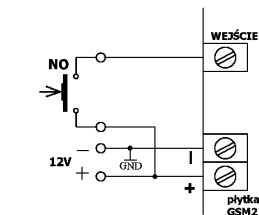

A. Input +12V controlled, NO
Activation level H

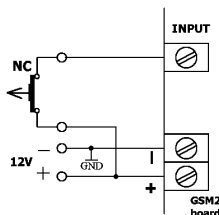

B. Input +12V controlled, NC
Activation level L

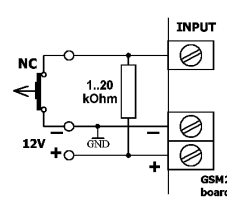

C. Input ground controlled, NO
Activation level L

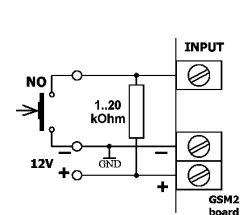

D. Input ground controlled, NC
Activation level H

NOTES!

1. Grounds of external control device and GSM2000 module must be short connected.
2. NC – normally closed state at standby. NO – normally opened state at standby.
3. Resistor in examples C and D in 1- 20kOhm range. Optimal value is 4.7 kOhm.

When CLIP call is made to phone number engaged or unavailable the call is redialled twice. First however, the module attempts to call remaining phones from predefined list and then returns to redial the undone call. Calls are considered done when:

- call is rejected;
- call is received and ended by call recipient;
- call is received but ended by the module due to notification time passage (up to 99s), defined in window “Other” **7.9**;
- call is not received nor rejected but defined in window “Other” **7.9** notification time out has passed (up to 99s).

If a call is either not rejected nor received but the defined in window “Other” **7.9** notification time has passed (up to 99s), the module would disconnect not assuming the call as done and will attempt to redial two times, but only if function “call once only” **7.10** is disabled.

2. „Outputs”.

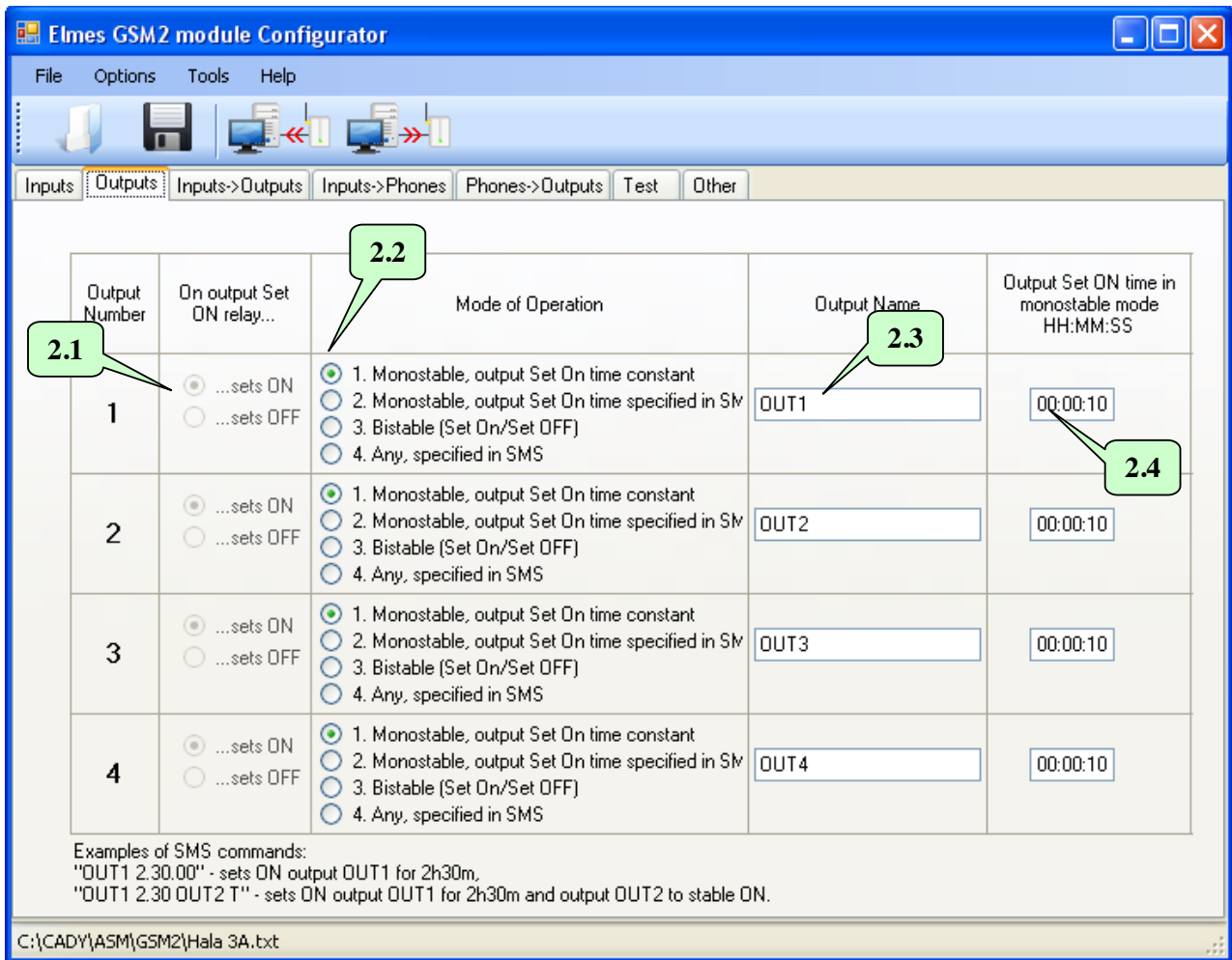

Elmes GSM2000 module features four relay control outputs. Each output has two installation terminals connected to relay output contacts and is jumper configured to operate in normally opened (NO), or normally closed (NC) mode (see pt. 8). Outputs can be operated in four control modes. This description covers only SMS control of outputs. Two other control modes: by CLIP (outputs controlled by calls made to module) and by input violation are described in windows “Phones->Outputs” and “Inputs->Outputs” respectively.

SMS text command pattern depends on selected operating mode of module’s outputs, as shown in field **2.2**:

Selected in 2.2 Operating Mode	Examples of SMS commands content and their meaning
1. Pulse Mode with preset set on time.	„OUT1” – Sets on output OUT1 for time preset in field 2.4
2. Pulse Mode with set on time defined in SMS text.	„OUT1 1:30” – Sets on output OUT1 for 1m30s „OUT1” – Sets on output OUT1 for time preset in field 2.4
3. Bistable Mode – on/off.	„OUT1 Y” or „OUT1” – Sets stable on output OUT1 „OUT1 N” – sets off output OUT1
4. Any mode defined in SMS command	„OUT1” – Sets ON output OUT1 for time preset in field 2.4 „OUT1 1:30:00” – Sets on output OUT1 for 1h30m „OUT1 Y” – Sets stable on output OUT1 „OUT1 N” – Sets off output OUT1

Remarks: command strings are space separated and quotation marks are not used!

- After applying name to an output, it should be then used in SMS commands, e.g. „STOVE 1:30:00” (switch on stove for 1h30m).
- In output bistable operation mode, letters T, Y, t, y can be used to mark set on while N, n to mark set off.
- In monostable (pulse) operation mode, output set on time can be specified as: HH:MM:SS, MM:SS or SS where “:” can be substituted by . / \ e.g. „OUT1 1.40.00” (one hour and 40 minutes); „OUT1 5/20” (5 minutes 20 seconds); „OUT1 6” (6 seconds).
- Single SMS command can control any number of outputs, e.g. „OUT1 OUT2 5 OUT3 T OUT4 12.00”.

Correct SMS command is executed immediately after its receipt and, if this option is selected, see **7.2**, confirmed by return SMS with “OK” + inputs/outputs status. If a command contained any error, such as improper output name, incorrect password or content, the command is not executed and, if this option is selected, see **7.2**, “ERROR” SMS is returned. Typical error could be SMS command “OUT1 Y” sent to output that operates in monostable mode (1 & 2) or, execution of SMS command “OUT1 5:00” when the output is defined to operate in mode 1 (Pulse Mode with predefined set on time).

Below listed, are all SMS control commands parameters that are set in various menus of the configuration software. These include:

- whether SMS command must begin with password – box **7.1** and the password - field **7.4** in window “Other”;
- whether SMS command letters case (lower or upper) has meaning - box **7.3** in window “Other”;
- whether the module confirms command execution by return SMS or, in case of error, confirms command rejection – field **7.2** in window “Other”;
- whether SMS command can be send from any phone - box **5.5**, or phone number in the list - boxes **5.3** & **5.4** in menu „Phones->Outputs”.

All outputs may have relay output set ON or set OFF on output activation, selected in field **2.1**. It does not mean whether relay contacts should close or open at output activation - that is NO-NC jumper preset manually on board of the module. It is whether the relay’s coil should be unpowered at standby and powered at set on or, alternatively, powered at standby and unpowered at set on. The second case is rarely used but has important meaning in sensing and alarming power supply cut off.

The GSM2000 outputs can be also controlled by calling (ringing) to the module’s phone number from one of its 2048 listed phones. Each of these phone numbers may have predefined one or many assigned outputs for simultaneous control. This mode allows programmed time pulse control of outputs only (bistable “on/off” operation is not permitted). The third and last available control mode of GSM2000 allows predefined output/s control by assigned to it input violation. This control mode does not allow bistable “on/off” operation either. Therefore, the function is set off as standard. To activate it select option **B.3** in menu „Options”.

3. „Inputs->Outputs”.

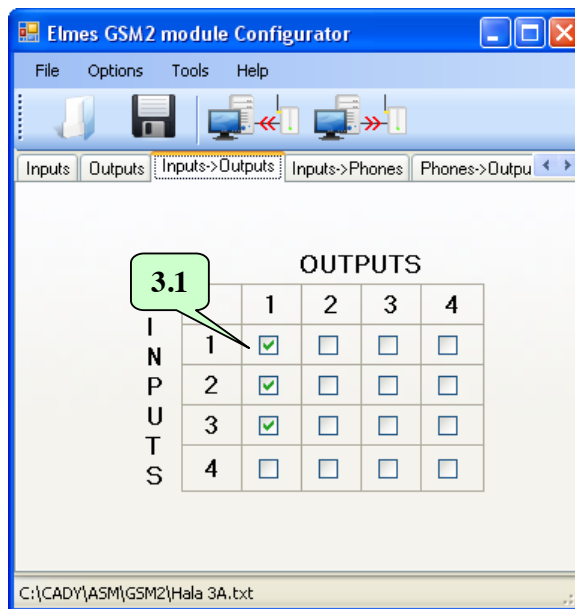

This menu allows selection of outputs activation by violation of inputs. By checking any selection box **3.1** violation of selected input would activate one or many outputs in operation modes described below:

1. For programmed time, if in menu “Outputs” in field **2.2** mode 1 or 2 is selected.
2. Permanently, until inputs returns to idle state, if in menu “Outputs” in field **2.2** mode 3 or 4 is selected.

As shown in the above window example, inputs 1, 2 or 3 set on activates output 1.

4. „Inputs->Phones”.

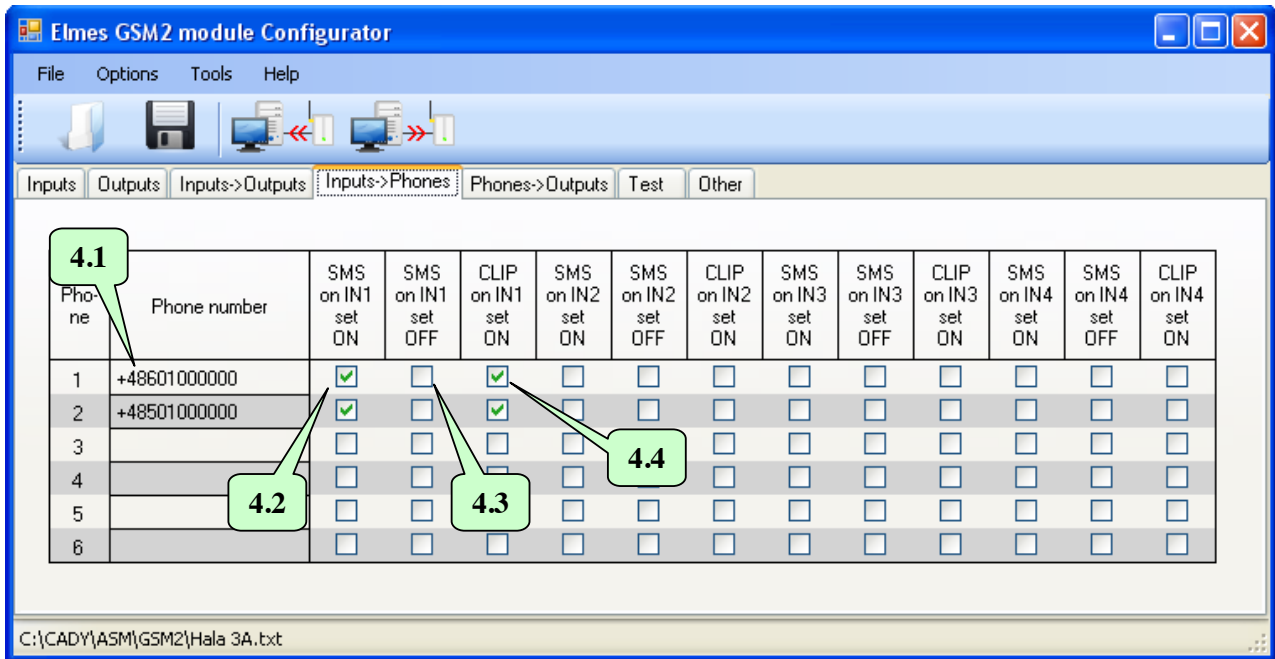

This window is for defining types of notifications that would be sent to first six phones on input set ON – box **4.2**, and set OFF - field **4.3**. Also, which phones would be called (CLIP notification) on input activation – box **4.4**. Shown phones - field **4.1** are for example purposes only. Phone numbers are input in window “Phones->Outputs”.

5. „Phones->Outputs”.

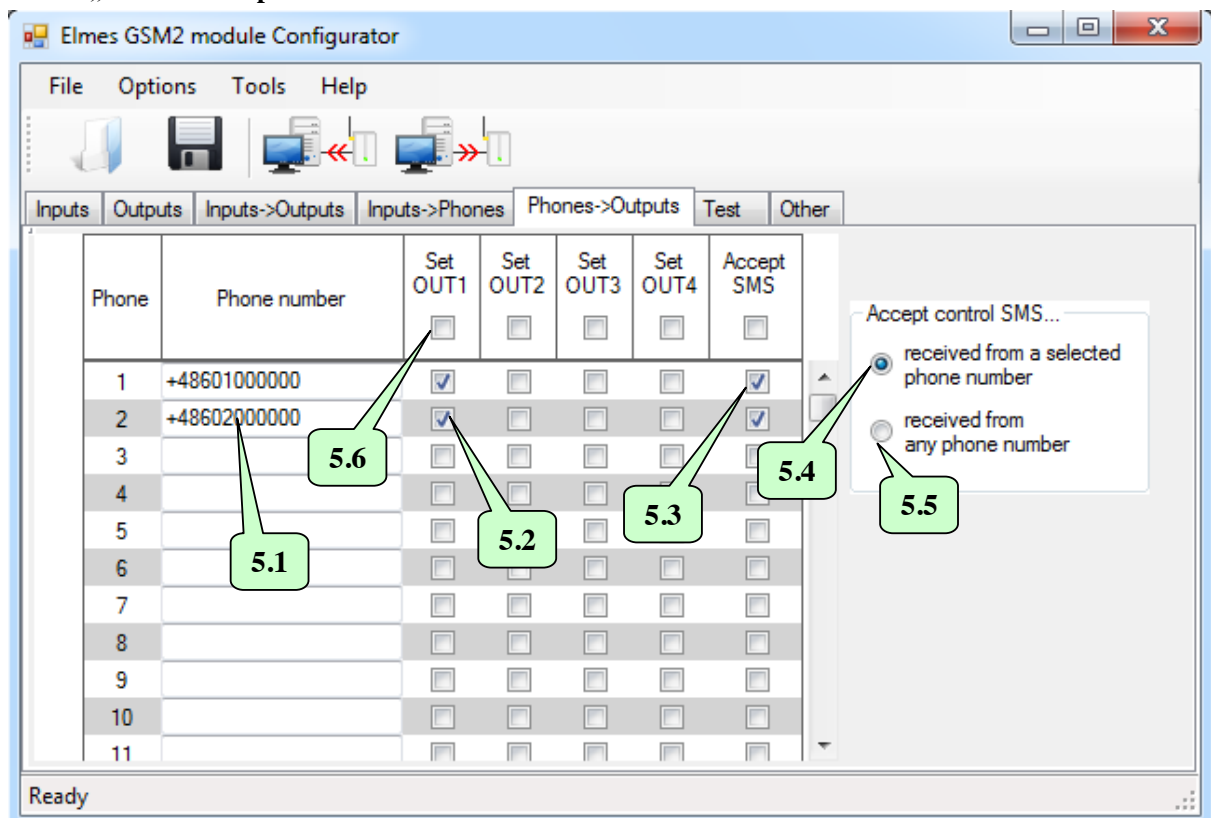

This window is designed to input phone numbers **5.1** that would operate with Elmes GSM2000. The list may contain up to 2048 phone numbers however, only the first 6 phones are entitled full functionality: can receive SMS and CLIP notifications on input violation (monitoring function) as well as can control module’s outputs with SMS and CLIP commands. The remaining phones (7...2048) can only be used to control module outputs. Boxes **5.2** (4 for each phone) define which outputs are activated on call from respective phone number. Outputs are activated for programmed time only (bistable (on/off) mode is unavailable), even it is defined so in window “Outputs”

If outputs are to be activated by SMS commands from any phone, box **5.5** should be checked. If outputs are to be activated by phones listed in the module only, box **5.4** should be checked. Boxes **5.3** are used for selecting phone numbers from which SMS commands are accepted.

Boxes **5.6** allow set on/off selected function to all phones on the list.

6. „Test”.

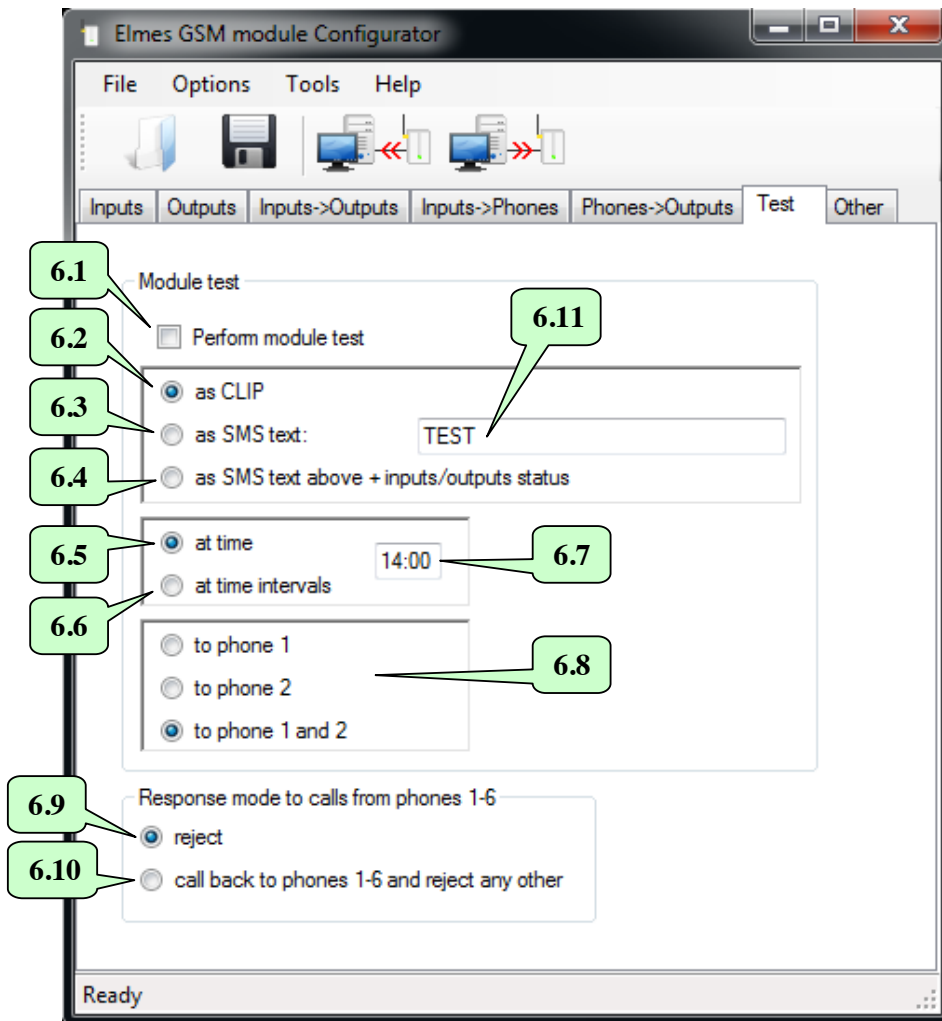

Periodical module’s communication test will be performed if box **6.1** is checked. The test will be made by CLIP calls if button **6.2** is checked or, with SMS text specified in field **6.11**, if button **6.3** is checked or, with SMS text specified in field **6.11** and inputs/outputs status, if **6.4** is selected. The test will be made to the first, the second or to both phone numbers, depending on selection made in field **6.8**.

By checking field **6.5** the test would be performed once daily, at time specified in field **6.7**. In that case, module’s real time clock should be set first either in GSM2 Configurator software by clicking field **8.6** in window “Tools->Diagnostics”, or remotely by sending SMS with text “password TIME HH:MM:SS” or, “password TIME HH:MM” with seconds omitted. Example: “abcd TIME 12:30:00” sets the real time clock to 12:30, where “abcd” stands for password and must read exactly as input in field **7.4**. IMPORTANT! Time setting SMS must include a valid password regardless of setting in field **7.1**.

By checking button **6.6** the test would be performed periodically, after passing preset in field **6.7** time interval, e.g. 12 hours. In that case, time to next test should be set in field **8.4** and button **8.6** checked in window “Tools-Diagnostics”. Periodical test can be forced to perform at any time by resetting test time counter, e.g. by sending SMS with “password RESTART” where password is defined in field **7.4**. Within a minute the test will be performed and next test will be made after preset time interval, e.g. after 12 hours. IMPORTANT! Time setting SMS must include a valid password regardless of setting in box **7.1**.

NOTICE! Disconnecting or switching off power supply results in module’s clock and time to next test counter reset. In that case, SMS text message should be send to the module setting the clock and SMS with test time command, if function **6.5** is checked or, send SMS resetting time count to next test, if function **6.6** is checked.

Module test can also be done at any time by calling module from any of its listed phones. The call would be rejected and, if option **6.10** is checked, a return call will be made. If option **6.9** is checked, then the module would only reject the call without making a return call, similarly as in the case of all other phones. In addition, GSM2000 module can be tested by SMS with "STATUS" text. In response we receive inputs/outputs status SMS. Format of this SMS is defined in boxes **7.14** and **7.15**.

7. „Other”.

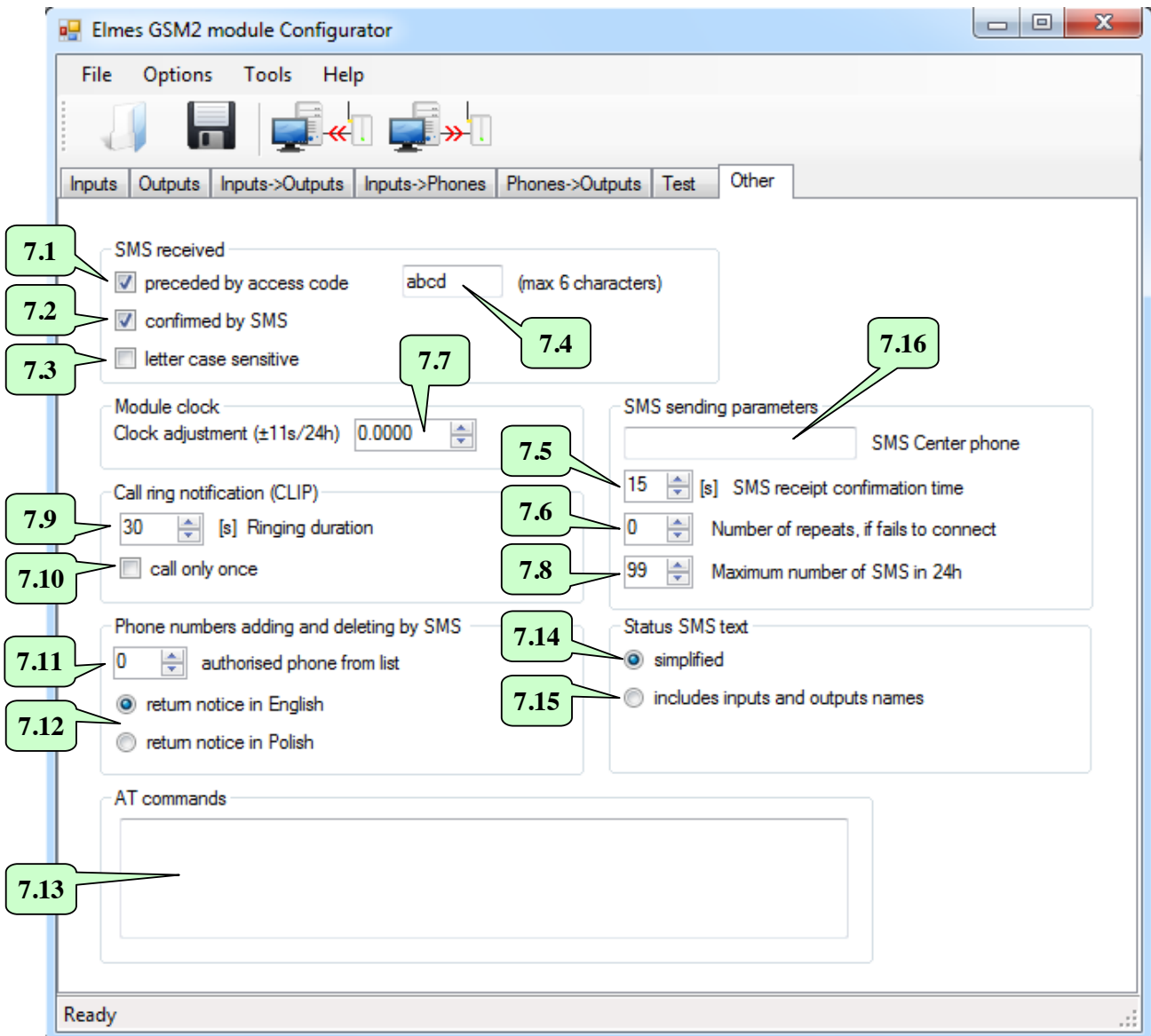

Check boxes **7.1**, **7.2**, **7.3**, **7.4** are designed to control the way module's outputs are operated by means of SMS commands and are described in detail in window "Outputs" (pt. 2).

Fields **7.5**, **7.6** and **7.16** were used in old firmware versions of the module. Since ver. 2.20 these fields are not used.

Field **7.7** allows correction of real time clock in the module. If the clock is fast then the value in the field should be decreased. If the clock is slow, the value should be increased. The adjustment allows -11 up to +11 seconds correction per day.

Field **7.8** allows sent SMS notifications limitation to within 10 and 200 a day. This function secures against high SMS cost in case of device failure.

Final field **7.9** defines how long the module would execute CLIP calls on input violation. After the preset time has passed, calls cease.

If box **7.10** is not checked, it means that in CLIP notification the module awaits call rejection. If, during the call, call rejection is not made, module disconnects and repeats calls twice. If **7.10** is checked, call is made only once even the call is not rejected. That does not refer to a control CLIP made always only once.

In field **7.11** we define a phone in list of phones from 1 up to 255 listed in “Phones->Outputs” menu. That phone can remotely, by SMS, add or delete a phone in the list. If “0” is put in field **7.11** it means no phone can perform this function. SMS that adds a phone to the list should read: “ADD +441234...” where +44 stands for international code for GB and 1234.. is beginning of sample phone number. Quotation marks must not be used. SMS that deletes a phone in the list should read: DEL +441234...” respectively. One SMS “ADD” or “DEL” command can add or delete more than one phone number separated by space. However, the total number of characters in that SMS cannot exceed 110 in 7-bit coding system or 50 in Unicode.

IMPORTANT! SMS adding a new phone to the module phone list can only add a phone but cannot define output/s it may control by CLIP (**5.2**) nor whether the module can accept SMS commands coming from it (**5.3**). These options are preselected using GSM Configurator software.

Buttons **7.12** are for language selection of module sent responses to SMS adding and deleting phones. It can be either Polish or English. Among other things, the response contains information on number of available free positions on the list of phones.

Selection buttons **7.14** and **7.15** are used to define status SMS pattern informing of module’s inputs/outputs state. If **7.14** is selected information on inputs/outputs state is send in simplified form. As an example, if module’s input 1 and output 2 are set on, status SMS will read: “IN1..4=1000, OUT1..4=0100”

If option **7.15** is selected, status SMS will contain names of inputs/outputs taken from their description fields. As an example, if one of outputs is named G2 and it will be set on then status SMS will include “G2” name.

Also, if in field **1.2** we describe SMS notification content on violation of input 1 as, for example, “TEMP. HIGH” and in field **1.3** describe input 1 violation cease as “TEMP. OK” then status SMS will read “TEMP. HIGH” on input violated and “TEMP. OK” on input not violated.

Example below shows sample of status SMS content (input 1 violated, inputs 2, 3 and 4 not used, outputs 1 and 3 set on and outputs 2 and 4 off):

```
“TEMP. HIGH, , , ,OUT1, ,OUT3,”
```

Module status SMS (inputs/outputs state) is send in the following circumstances:

1. In response to SMS text “STATUS”.
2. In response to SMS controlling module’s outputs.
3. Periodically at module’s test, if option **6.4** is on.

NOTICE 1: Long names should not be used as SMS longer than 160 characters will be cut.

NOTICE 2: Due to hardware limitations, function **7.15** activates only after USB cable is connected to the module.

Field **7.13** is recommended for experienced users and as standard remain blank. The field is used for inputting AT commands that will be send to radio module at every restart (e.g. on power supply connection). Complete description of all available commands user can find in manufacturer’s documentation of radio module used in GSM2000. Listed below are set of commands allowing remote, by the use of SMS, execution of AT commands (applies only to GSM chipset type Telit GL865).

```
AT#SMSATRUNCFG=3,1,2
AT#SMSATRUN=1
AT#SMSATWL=0,1,0,"+44xxxxxxxx"
```

Last command adds phone number "+44xxxxxxxx" to position 1 of eight phone numbers authorised to remotely execute AT commands of phones. NOTE! This list does not refer to “Phones-Outputs” menu while a phone may appear on both lists.

In the next step, the module should be restarted. From now on AT commands can be remotely executed from this phone number. Now, above commands may be removed from window **7.13** as settings are permanently memorised in the memory of radio module. If, at later date, the phone number is to be removed from list of authorised numbers, the following command should be executed:

```
AT#SMSATWL=1,1
```

where digit 1 means remove phone command and digit 2 stands for number of phone deleted from list (1..8).

In order to set OFF remote AT commands execution for all listed phones, following command should be performed:

```
AT#SMSATRUN=1
```

One of useful commands is AT+COPS. It allows force log on to other than default mobile network operator, if allowed. In order to take advantage of this option first we need to check what networks are available. To do so SMS containing below command should be send to the module:

```
AT+COPS=?
```

After a longer while the following response SMS should be received reading (example in Poland):

```
+COPS: (2,"Play",,"26006"),(1,"T-Mobile",,"26002"),(1,"Plus",,"26001"),(3,"Orange",,"26003"),(0-4),(0,2).
```

The first digit in all brackets stands for: 2- current GSM network operator, 1- available operator, 3- operator forbidden. As it stands, currently selected operator is „PL 06” with code 26006. Now, if we would wish to change operator to e.g. „Plus GSM” the following command should be send:

```
AT+COPS=1,2,26001.
```

If change is required to „T-Mobile” GSM network operator:

```
AT+COPS=1,2,26002.
```

„Orange” network operator is not allowed in the example.

If standard configuration is to be restored, in which module automatically selects mobile network, following command should be send:

AT+COPS=0

Next useful command is request for GSM network signal level quality check:

AT+CSQ

In response, SMS is received with sample text:

+CSQ: 28,0

where 28 is the network signal level from 0..31 range.

AT commands should be input in field **7.13**. The commands will be executed at start of module operation. Example of such AT command may be command forcing GSM network operator change. In Poland, to force select PLUS operator (code 26001) the following AT command may be used: AT+COPS=1,2,"26001". GSM network operator's code is required to force operator change by AT command. List of such codes in various countries may be found at:

<http://mcclist.com/mobile-network-codes-country-codes.asp>

First three digits of network operator constitute country code (MCC – mobile country code), e.g. 260 for Poland. Last two digits stand for code of network (MNC – mobile network code).

8. „Diagnostics”.

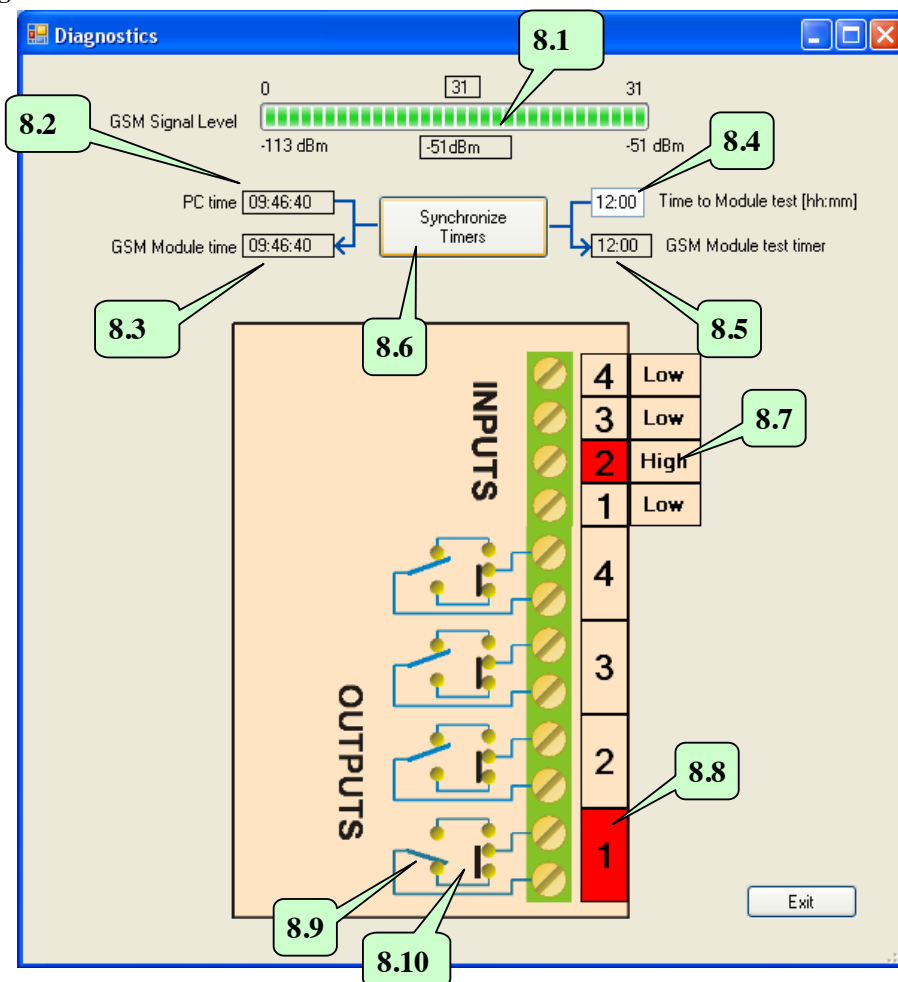

Window “Diagnostics” is available in menu “Tools”. Before entering the window, it should be made sure that the module is USB cable connected to computer.

GSM signal bar line **8.1** displays quality level of communication of the module with GSM base station in physical units (from -113 up to -51dBm, where -51dBm represent very good level while -113dBm very poor level. Displayed number of bars (0-31) is symbolic representation of signal level only.

Fields from **8.2** to **8.6** are used in module time and test synchronization and were described in window “Test” – pt. 6. Just to remind that clicking button **8.6** clock time of the module is synchronized with clock of computer and time to next test from field **8.4** is send to module's counter.

Whether test would be performed at specified time daily or, after specified time interval and its set timing, it is defined in window "Test".

It should be noted that field **8.5** shows time to next test counter in the module and decreases every minute if **6.6** is checked. Field **8.3** displays current clock time in the module.

Window diagram shows selected inputs activation signal level (High or Low) and whether inputs are currently activated (colour red) – as seen in field **8.7**.

The diagram present also outputs state of the module. For example, **8.9** shows relay contacts state of output 1. The output is currently activated as shown by red colour in field **8.8**. Whether output should be opened (NO) or closed (NC) at standby is jumper selected **8.10** on module's board.

NOTICE! Diagram shows jumper state as delivered by manufactured – not their actual state.

9. Firmware update.

Firmware update is done in "Tools-Firmware Update" window menu.

First step is to download new firmware file from the manufacturer's web site - www.elmes.pl and save it to PC disk.

Next, the Configurator software prompts to start update process and shows up firmware version downloaded and version in the module. If downloaded version is older or the same as installed in the module, the update process is not necessary and can be discontinued.

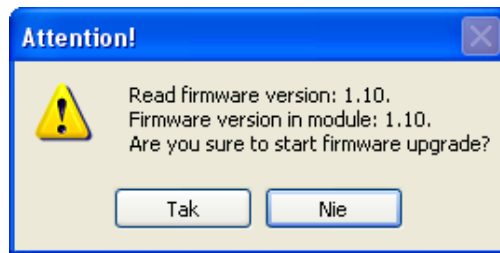

By clicking "Yes" the firmware update process is started. When it ends power supply should be switched off.

NOTICE! If, while in the firmware updating procedure, power supply gets cut off, module LED would light steady on power return. The entire firmware update procedure should then be repeated. Firmware procedure can also be force initiated by switching on power supply with jumper JP on.

10. FAQ – what to do if.. ?

1. The Module does not send SMS?

Answer: the GSM network operator SMS service centre phone number is either missing or has been input improperly (see fig. 5 above).

2. The Module hangs on if +V of power supply is connected to any of its IN1..4 control inputs?

Answer: the reason for that is voltage higher than +15V. It happens when the module is powered by not stabilized power supply and the supply +V is used to control the module's inputs. If so, at module's standby (the GSM2000 module average current draw is 5 mA) the power supply voltage can be as high as 20V(!) while maximum allowable control voltage is 15VDC. The use of stabilized 12VDC power supply solves the problem. Alternatively, high voltage level at module's inputs may be reduced to 10..15V by the use of individually selected resistors in range of 4k7...27kOhm.

This problem refers to modules with mini-USB socket manufactured between 12.2010 – 02.2011 only.

3. The Module does not initialize (LED flashes fast in 1s rate then sets off for few seconds and starts flashing cycle again)?

Answer 1: check for proper SIM card contacting in the SIM socket. If necessary, clean all contacts with spirit cleaner.

Answer 2: SIM card PIN code is other than required 1234 or, PIN-less SIM card is used in module with firmware version earlier than 2.11.

Answer 3: power supply unit has insufficient current draw rating. Though average current draw of the module at outputs set off is less than 5 mA, it can be as high as 1 Amperes in short transmission pulses leading to the module's reset if insufficient current rating power supply is used.

4. On attempt of sending to or receiving data from the module while in communication mode with PC „Out of Time” message appears?

Answer 1: improper COM port is selected in Options->Settings menu. The COM number should match that what appears when USB cable is plugged to PC and what disappears when unplugged.

Answer 2: the USB interface drivers are either not installed at all or installation is faulty. Drivers are available for download at www.elmes.pl. After installation a new COM port should appear. Incorrect driver folder name given at installation is a frequent mistake. Proper driver folder name for modules with mini-USB socket currently manufactured is „VER 2A”.

If driver installation has failed, it should be uninstalled with the cable still plugged, then unplug the cable, plug to PC again and follow cable installation steps described at top of this manual.

Answer 3: check module's connections with PC and power supply unit.

Answer 4: if none of the above solves the problem, follow steps as below:

- a. unplug and plug USB cable to the PC or,
- b. switch off module's power supply and unplug USB cable from the PC, then switch on module's power supply and plug the USB cable to the PC.
- c. plug in USB cable to other USB socket in the PC.

5. *The „GSM2 Configurator” software does not start up?*

Answer: missing Windows® component: „Microsoft.NET Framework 2.0”. It can be downloaded from Microsoft® web site and installed on PC.

6. *On attempt of sending or receiving data from GSM2000 module „Access to port COM-x is denied „message appears?*

Answer: this error may be due to other software application using this port. For example, “Sony Ericsson PC Suite” periodically tests COM ports for a phone presence and, in consequence, block the port access. To solve the problem the following steps should be tried:

- a. wait few seconds and try data exchange again,
- b. disable software application blocking the port.

7. *On attempt of sending or receiving data from GSM2000 module “The port COM3 does not exist” notice appears?*

Answer: after selecting proper COM3 port in menu Options, the USB cable was PC unplugged.

8. *After sending SMS command to GSM2000 module, the module responds with “OK” but the outputs are not set?*

Answer 1: the reason for this is that the password is the same as name of one of the outputs. Even if the function “SMS command must begin with password” is set off, any output name cannot be the same as password.

Answer 2: SMS sent was 16 data bits coded, not 7 bits. To eliminate the problem, SMS coding mode should be changed in phone from which the SMS commands were sent or, firmware in the GSM2000 module should be upgraded to latest version.

9. *On attempt of sending or receiving data from PC to the GSM2000 module „Incorrect Parameter” message appears?*

Answer: the reason may be not up to date Window XP system. The problem may occur only with RS-USB converter with MCP2200 chip and pcb initials “GSM2T-USB”. To solve the problem two Windows XP update patches (KB918365 and KB935892) should be downloaded from Microsoft® Windows site and installed in the PC. Alternatively, installing “Service Pack 3” for Windows XP would also clear the matter as it includes both update patches.

IF problem is of other nature from what is described above, please read description of module's subsequent firmware updates and install latest firmware version, if necessary. If that does not solve the problem, please contact Elmes Electronic Service at service@elmes.pl